



725 North 1000 West, Centerville UT 84014
 Ph. 801-295-3443 Toll free 800-933-5038 fax 801-295-3485 WWW.BARTILE.COM

NEW ENGLAND SLATE

DISTRIBUTOR _____ DATE _____

CONTRACTOR _____ COLOR _____

CUSTOMER NAME _____ STD. WT. ULTRALITE SUPER DUTY

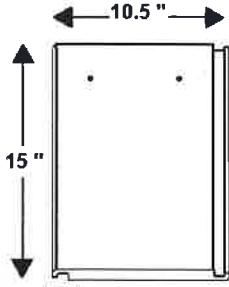

STANDARD CUT QTY _____



RUFF CUT QTY _____



COTTAGE * QTY _____

* ADD 12% - 15%
FIELD TILE
AND RAKES



MANCHESTER * QTY _____

* ADD 12% - 15%
FIELD TILE
AND RAKES



NEWCASTLE * QTY _____

* ADD 12% - 15%
FIELD TILE
AND RAKES

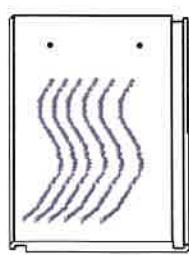

70% RANDOM
SWIRL BRUSHED
QTY _____



70% VINTAGE
RUFF MOSS
QTY _____

TRIM OPTIONS

- RUFF-CUT
- 70% SWIRL BRUSHED
- 70% VINTAGE RUFF-MOSS



TILE RISER
3" x 12"
QTY _____



VENTILLATED BATTEN
(PAINTED BLACK)
1.5" x 4 FEET
QTY _____

SLATE TRIM UNITS

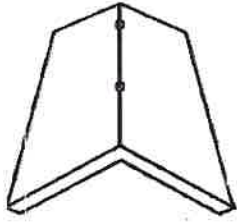

V STYLE HIP / RIDGE
QTY _____

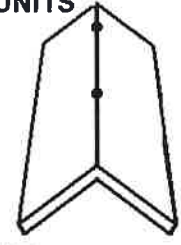

STEEP RIDGE
QTY _____

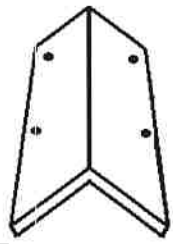

UNIVERSAL RAKE
QTY _____

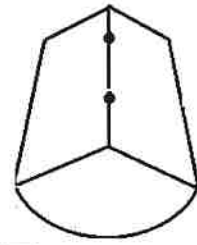

V STYLE
HIP STARTERS
QTY _____

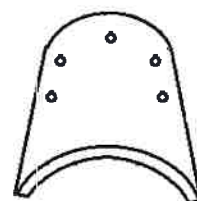

USR HIP / RIDGE / RAKE
QTY _____

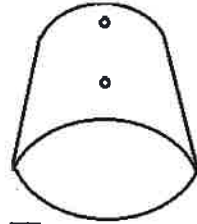

USR HIP STARTERS
QTY _____

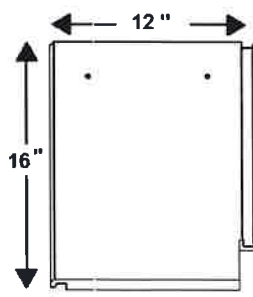

YORKSHIRE
QTY _____

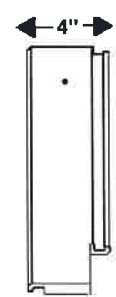
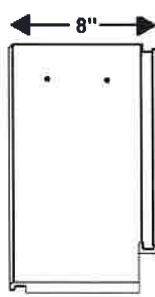

ORDER WILL BE MANUFACTURED AS CHOSEN.
NO RETURNS ON TILE OR ACCESSORIES.

CUSTOMER ACCEPTANCE _____

SIGNATURE



725 North 1000 West, Centerville UT 84014
 Ph. 801-295-3443 Toll free 800-933-5038 fax 801-295-3485 WWW.BARTILE.COM

SPLIT TIMBER

DISTRIBUTOR _____ DATE _____

CONTRACTOR _____ COLOR _____

CUSTOMER NAME _____ STD. WT. ULTRALITE SUPER DUTY

SPLIT TIMBER FIELD TILE

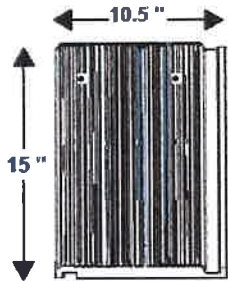

STANDARD CUT
QTY _____



RUFF CUT
QTY _____



COTTAGE *
QTY _____

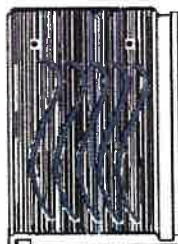

70% RANDOM SWIRL BRUSHED
QTY _____



70% VINTAGE RUFF MOSS
QTY _____

TRIM OPTIONS

- RUFF-CUT
- 70% SWIRL BRUSHED
- 70% VINTAGE RUFF-MOSS

TILE RISER
3" x 12"



QTY _____

VENTILLATED BATTEN
(PAINTED BLACK)
1.5" x 4 FEET

QTY _____

* ADD 12% - 15%
FIELD TILE
AND RAKES

SPLIT TIMBER TRIM UNITS



V STYLE HIP / RIDGE
QTY _____

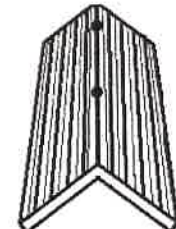

STEEP RIDGE
QTY _____

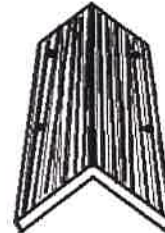

UNIVERSAL RAKE
QTY _____



V STYLE HIP STARTERS
QTY _____

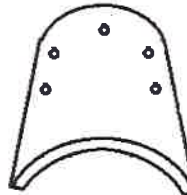

USR HIP / RIDGE / RAKE
QTY _____

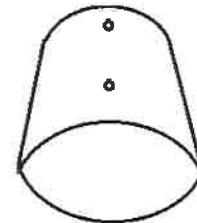

USR HIP STARTERS
QTY _____

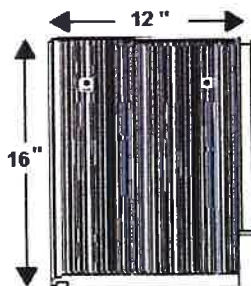

YORKSHIRE
QTY _____

ORDER WILL BE MANUFACTURED AS CHOSEN.
NO RETURNS ON TILE OR ACCESSORIES.

CUSTOMER ACCEPTANCE _____



725 North 1000 West, Centerville UT 84014
 Ph. 801-295-3443 Toll free 800-933-5038 fax 801-295-3485 WWW.BARTILE.COM

EUROPEAN

DISTRIBUTOR _____ DATE _____

CONTRACTOR _____ COLOR _____

CUSTOMER NAME _____ STD. WT. ULTRALITE SUPER DUTY

EUROPEAN FIELD TILE

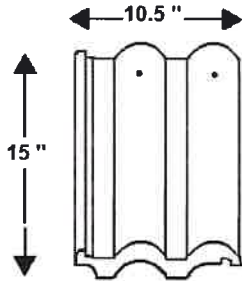

STANDARD
QTY _____

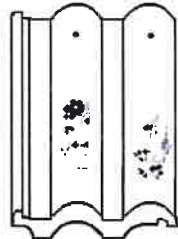

70% VINTAGE
RUFF MOSS
QTY _____



70% RANDOM
SWIRL BRUSHED
QTY _____



EUROPEAN
EAVE CLOSURES
9.5" COVERAGE
ACROSS EAVE
QTY _____

EUROPEAN TRIM UNITS

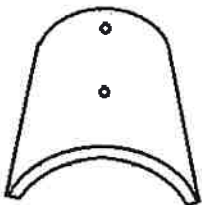

HIP / RIDGE / RAKE
QTY _____

TRIM OPTIONS

- 70% SWIRL BRUSHED
- 70% VINTAGE RUFF-MOSS

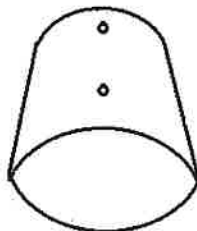

HIP STARTERS
QTY _____

BARTILE MISSION TAPER TILE SYSTEM

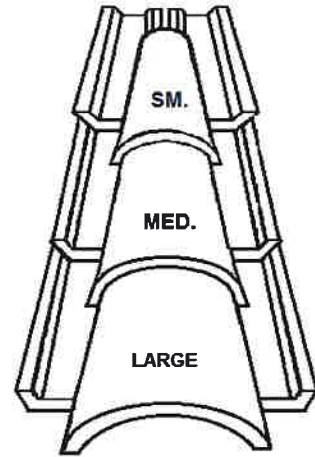

NEED TO SEND:

DIAMETER _____

PITCH _____

EAVE TO POINT _____



TURRET
CLOSURES
QTY _____

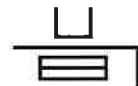

COVER TRACK WITH STRIPVENT
COLOR _____ QTY _____
QTY _____

ORDER WILL BE MANUFACTURED AS CHOSEN.
NO RETURNS ON TILE OR ACCESSORIES.

CUSTOMER ACCEPTANCE _____

SIGNATURE



725 North 1000 West, Centerville UT 84014
 Ph. 801-295-3443 Toll free 800-933-5038 fax 801-295-3485 WWW.BARTILE.COM

SIERRA MISSION

DISTRIBUTOR _____ DATE _____

CONTRACTOR _____ COLOR _____

CUSTOMER NAME _____ STD. WT. ULTRALITE SUPER DUTY

SIERRA MISSION FIELD TILE

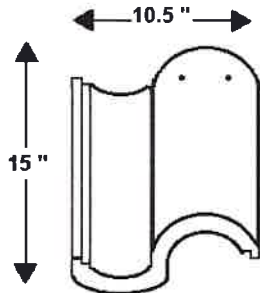

STANDARD
 QTY _____



70% VINTAGE
 RUFF MOSS
 QTY _____

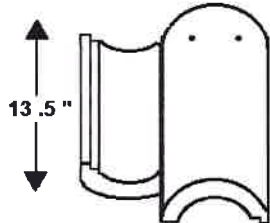

OLD MISSION *
 QTY _____

* ADD 12% - 15%
 FIELD TILE
 AND RAKES

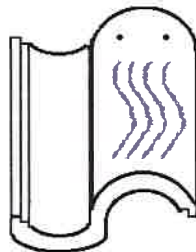

70% RANDOM
 SWIRL BRUSHED
 QTY _____



MISSION
 EAVE CLOSURES QTY _____

SIERRA MISSION TRIM UNITS

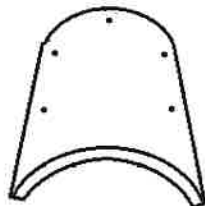

MISSION
 HIP / RIDGE / RAKE
 QTY _____

TRIM OPTIONS

- 70% SWIRL BRUSHED
- 70% VINTAGE RUFF-MOSS

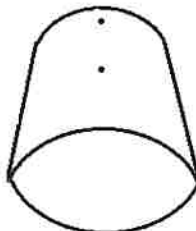

MISSION
 HIP STARTERS
 QTY _____

BARTILE MISSION TAPER TILE SYSTEM

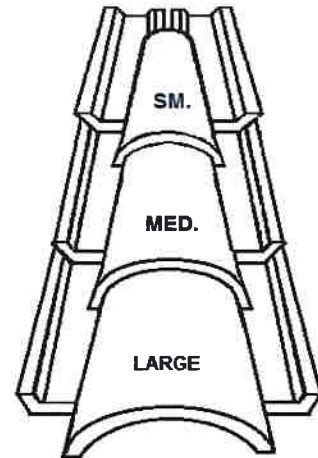

NEED TO SEND:

DIAMETER _____

PITCH _____

EAVE TO POINT _____

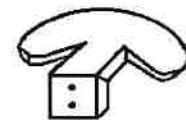

TURRET
 CLOSURES
 QTY _____



COVER TRACK WITH STRIPVENT
 COLOR _____ QTY _____
 QTY _____

ORDER WILL BE MANUFACTURED AS CHOSEN.
 NO RETURNS ON TILE OR ACCESSORIES.

CUSTOMER ACCEPTANCE _____

SIGNATURE _____

LEGENDARY SLATE

DISTRIBUTOR _____ DATE _____

CONTRACTOR _____ COLOR _____

CUSTOMER NAME _____ STD. WT. ULTRALITE SUPER DUTY

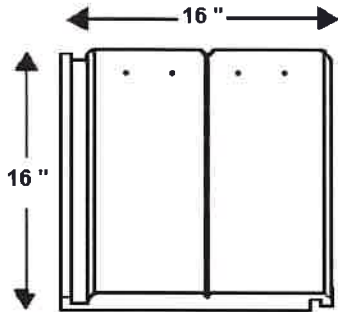

STANDARD CUT

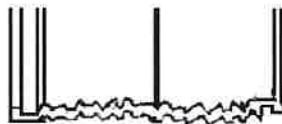

RUFF CUT



COTTAGE *

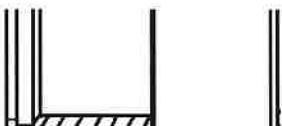

TOSCANA CUT

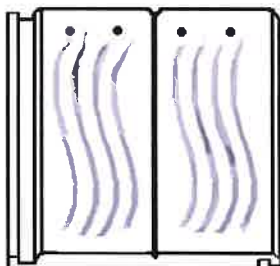

- 70% RANDOM SWIRL BRUSHED
- 100% STRAIGHT BRUSHED
- 50% STRAIGHT BRUSH (ONE SIDE ONLY)

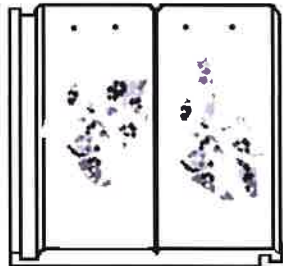

70% VINTAGE RUFF MOSS

TRIM OPTIONS

- RUFF-CUT
- 70% SWIRL BRUSHED
- 70% VINTAGE RUFF-MOSS



TILE RISER
 3" x 12"
 VENTILLATED BATTEN
 (PAINTED BLACK)
 1.5" x 4 FEET

* ADD 10% MORE TILE



SIGNATURE SLATE

SLATE TRIM UNITS

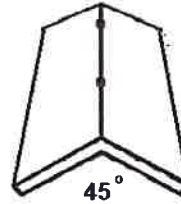

V STYLE HIP / RIDGE
 5/12 - 8/12 PITCH

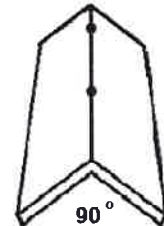

STEEP RIDGE
 9/12 - STEEPER PITCH

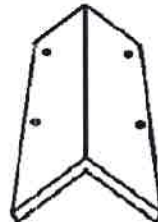

UNIVERSAL RAKE

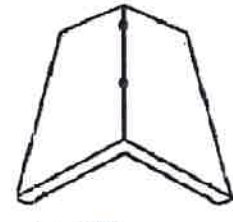

LOW PITCH
 2/12 - 4/12

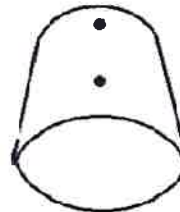

USR HIP STARTERS

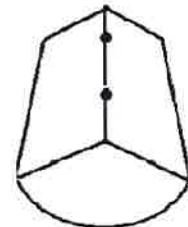

V STYLE HIP STARTERS

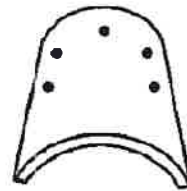

UNIVERSAL RAKE

- RAKE METAL OPTION
- SOLID GABLE TILES
- VENTILLATED BATTENS FOR FIELD TILE (1X4')
- 2.5" NAILS RINGSHANKS

ORDER WILL BE MANUFACTURED AS CHOSEN.
 NO RETURNS ON TILE OR ACCESSORIES.

CUSTOMER ACCEPTANCE _____

SIGNATURE



725 North 1000 West, Centerville UT 84014
 Ph. 801-295-3443 Toll free 800-933-5038 fax 801-295-3485 WWW.BARTILE.COM

LEGENDARY SPLIT TIMBER

DISTRIBUTOR _____ DATE _____

CONTRACTOR _____ COLOR _____

CUSTOMER NAME _____ STD. WT. ULTRALITE SUPER DUTY

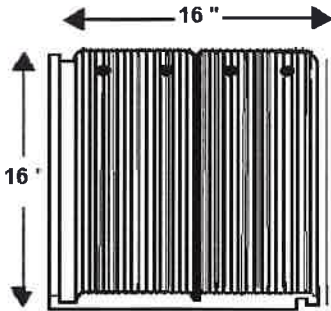

STANDARD CUT



RUFF CUT



COTTAGE *



TOSCANA CUT



SIGNATURE SLATE

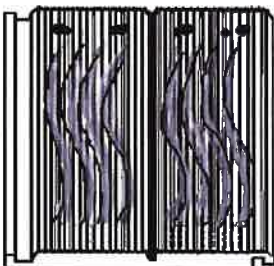

70% RANDOM SWIRL BRUSHED

100% STRAIGHT BRUSHED

50% STRAIGHT BRUSH (ONE SIDE ONLY)

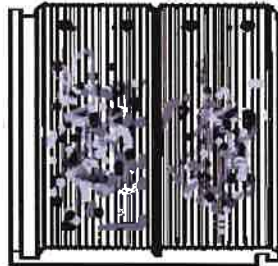

70% VINTAGE RUFF MOSS



TILE RISER
3" x 12"

VENTILLATED BATTEN
(PAINTED BLACK)
1.6" x 4 FEET

* ADD 10% MORE TILE

SPLIT TIMBER TRIM UNITS

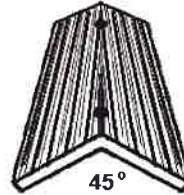

45°

V STYLE HIP / RIDGE
5/12 - 8/12 PITCH

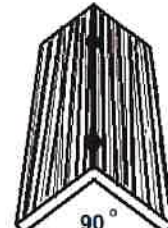

90°

STEEP RIDGE
9/12 - STEEPER PITCH

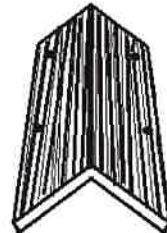

UNIVERSAL RAKE



LOW PITCH
2/12 - 4/12

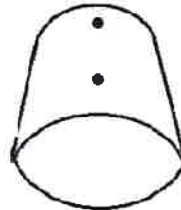

USR HIP STARTERS

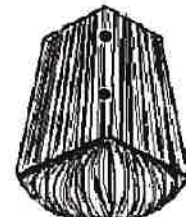

V STYLE HIP STARTERS



UNIVERSAL RAKE

RAKE METAL OPTION

SOLID GABLE TILES

VENTILLATED BATTENS FOR FIELD TILE (1X4')

2.5" NAILS RINGSHANKS

ORDER WILL BE MANUFACTURED AS CHOSEN.
NO RETURNS ON TILE OR ACCESSORIES.

CUSTOMER ACCEPTANCE _____

SIGNATURE